

BRITISH

JAEGER

DASHBOARD
INSTRUMENTS

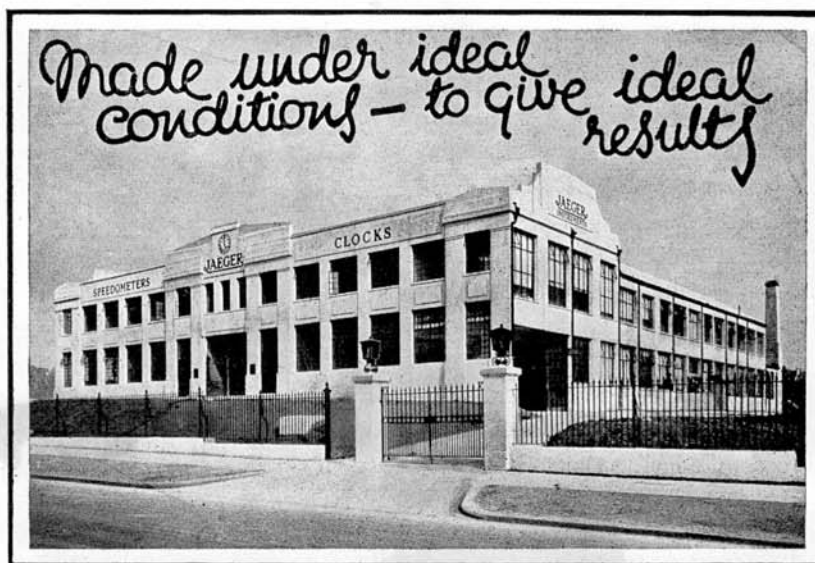

Manufacturers of
**SPEEDOMETERS FOR CARS AND
 MOTOR CYCLES**

also

CLOCKS, WATCHES, REVOLUTION
 INDICATORS, OIL AND PETROL
 GAUGES, RADIATOR THERMOMETERS
 COMBINED REV-CLOCK, MILEAGE
 RECORDERS, Etc., Etc.

BRITISH JAEGER INSTRUMENTS LTD.

Offices and Works :

**Chronos Works, North Circular Road,
 LONDON, N.W.2.**

Telephone :
 GLADSTONE 1136 (5 lines)

Cablegrams :
 JAEGOMETER, LONDON

Telegrams :
 JAEGOMETER, GOLD, LONDON

Code :
 BENTLEY'S

Directors : W. HENDERSON-CLELAND (British) A. GORDON SMITH (British) G. DELAGE (French) H. R. BUCKLAND (British)
 FOR LIST OF SERVICE STATIONS SEE PAGES 4 AND 5.



INTRODUCTION



THE Jaeger Speedometer is British made throughout and is incomparably the finest speedometer obtainable. It is manufactured in a Works which was specially built to make Escapements and other Clock parts where scientific accuracy is required. In these Works, manufacturing limits of '0005 in. are habitual.

The design and construction of the Jaeger Speedometer is on the lines of a watch; in fact, it incorporates an escapement. As the result of this design, no matter how severe the vibration from bad roads, the hand remains absolutely steady and records with unfailing accuracy. This Chronometric principle of construction demands a considerably higher precision of workmanship than that ordinarily associated with such instruments.

In the racing world most famous drivers pin their faith to the Jaeger racing instruments on their cars.

It is of interest to note that the following British manufacturers of high grade motor-cars standardise Jaeger instruments on their productions:—

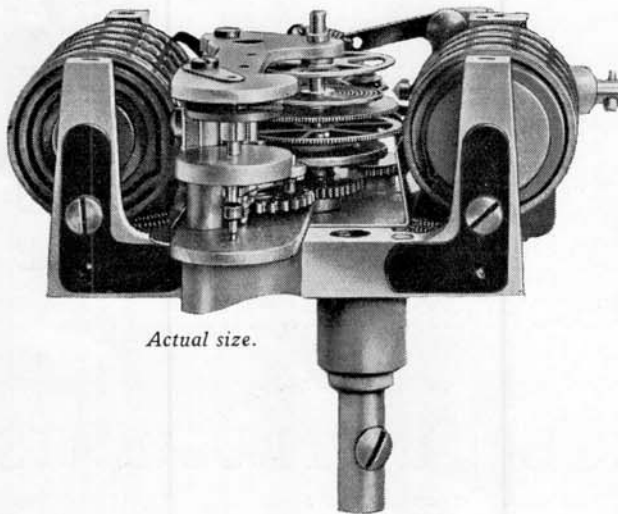

Citroen.
Crossley.
Humber.
Lea-Francis.
M.G.
Riley.
Rover.
S.S.
Singer.
Standard.
Sunbeam.
Talbot.
Triumph.
Etc., Etc.

Actual size.

The majority of Continental chassis manufacturers also fit Jaeger instruments.



BRITISH

JAEGER

INSTRUMENTS



CHRONOS WORKS
NORTH CIRCULAR ROAD
LONDON, N.W.2.

TELEPHONE:
GLADSTONE 1136 (5 LINES)
TELEGRAMS:
JAEGOMETER GOLD, LONDON



GUARANTEE AND TERMS OF BUSINESS



All Jaeger instruments are guaranteed against defects in material or workmanship for a period of six months from date of delivery of vehicle. This guarantee is conditional upon the instrument not having been opened or interfered with, and provided the defect is not caused by ordinary wear and tear, negligence or accident.

Should your instrument not be functioning correctly, please return it carriage paid (complete with cable in the case of speedometer or similar instrument), when expert attention will be given without delay.

Consequential damages of any kind are not included in our guarantee.

CONDITIONS OF SALE

All Jaeger instruments are sold on the distinct understanding that they will not be listed, offered or sold by Factor or Dealer at less than our fixed wholesale or retail prices, and no discounts or allowances are to be made off such prices. All our goods are sold or offered for sale strictly upon the condition that same in turn will not be sold or offered for sale by auction whether separately or as component parts. Infringement of the above conditions implies immediate discontinuance of supplies.

Goods are only supplied by us on condition that they are not exhibited by any person, Firm or Company at any Exhibition or Show held in the United Kingdom, other than those held or approved of by the Society of Motor Manufacturers and Traders, Ltd. Any breach of these conditions will render the purchaser liable to indemnify us in respect of our liability under the Society's bonds, to pay the Society such damages as the Committee or Council of the Society may award.

Remittances should accompany all orders unless a current account is opened.

Orders by telegram can only be executed when customers have a current account or are known to the firm.

When ordering, please quote Type No. and Page No. of the article required, name of article, finish and size, in order to avoid any possibility of error.

Prices are liable to alteration at any time without notice.

Carriage and postal charges are charged to our customers.



CHRONOS WORKS
NORTH CIRCULAR ROAD
LONDON, N.W.2.

BRITISH

JAEGER

INSTRUMENTS



TELEPHONE:
GLADSTONE 1136 (5 LINES)
TELEGRAMS:
JAEGOMETER, G.O.D., LONDON

PRINCIPAL SERVICE STATIONS AND AGENTS

GREAT BRITAIN

British Jaeger Instruments Ltd., Chronos Works, North Circular Road, London, N.W.2

BIRMINGHAM

S. Smith & Sons (M.A.) Ltd., 33, Cox Street, Livery Street.

MANCHESTER

S. Smith & Sons (M.A.) Ltd., 14a, Jackson's Row.

GLASGOW

G. M. Smith, 21, Drury Street.

NORTHERN IRELAND

Turnpenny & Co., 18, Sussex Place, Belfast.

IRISH FREE STATE

Buckleys Motors Ltd., 34, Lower Abbey Street, Dublin.

AUSTRALASIA

SERVICE REPRESENTATIVE FOR AUSTRALIA AND NEW ZEALAND

G. Betteridge, Esq., P.O. Box 190, Haymarket P.O., Sydney, N.S.W.

NEW SOUTH WALES

Sales and Service

Smith Sons & Rees Ltd., 30/2, Wentworth Avenue, Sydney.

QUEENSLAND

Sales and Service

Butler Bros. (Australia), Ltd., 119-121, Creek Street, Brisbane.

SOUTH AUSTRALIA

Sales and Service.

Lenroc Ltd., 211/5, Pultney Street, Adelaide.

VICTORIA

Sales and Service

Keep Bros. & Wood (Pty.) Ltd., 200, Latrobe Street, Melbourne, C.I.

WEST AUSTRALIA

Sales and Service

M. J. Bateman Ltd., 12, Milligan Street, Perth.

NEW ZEALAND

NORTH ISLAND

Sales and Service

H. E. W. Silver Magneto Co., 30/2, Lower Tory Street, Wellington.

SOUTH ISLAND

Sales and Service

Watson, Steele & Ganley, Wellesley Street West, Auckland.

Andersons Ltd., P.O. Box 90, Christchurch.

ARGENTINE

W. Stephen, Esq., Chacabuco 1339, Buenos Aires.

BRAZIL

Soc. Anon., Thornycroft do Brasil, Rio de Janeiro.

BRITISH WEST INDIES

B.S.A. Agency Ltd., 58, King Street, Kingston, Jamaica.

EGYPT

Anglo-Egyptian Taximeter Co., Ltd., 12, Sharia Charkass (Sahel-Boulac), Cairo.

BRITISH

JAEGER

INSTRUMENTS

CHRONOS WORKS,
NORTH CIRCULAR ROAD
LONDON, N.W.2.

TELEPHONE:
GLADSTONE 1136 (8 LINES)
TELEGRAMS:
JAEGERMETER. GOLD, LONDON

PRINCIPAL SERVICE STATIONS AND AGENTS (continued)

FEDERATED MALAY STATES Malayan Motors Ltd., Orchard Street,
Singapore.

INDIA

BOMBAY PRESIDENCY The French Motor Car Co., 15, New
HYDERABAD AND CENTRAL Queen's Road, Girgaon, Bombay.
PROVINCES

BENGAL, ASSAM, BIHAR, Thornycroft (India) Ltd., 48, Diamond
CRISSA, AND THE UNITED Harbour Road, Alipore, Calcutta.
PROVINCES, NOT INCLUD-
ING DELHI

MADRAS AND ALL INDIAN Addison & Co., Mount Road, Madras.
STATES SOUTH OF
HYDERABAD

CEYLON Tucker & Co., P.O. Box 330, Union Place,
Colombo.

SOUTH AFRICA

CAPE OF GOOD HOPE Stansfield Ratcliffe & Co., Ltd., 9, Water-
(West Province) kant Street, Post Box 797, Cape Town.

Stansfield Ratcliffe & Co., Ltd., 44, De
Beers Road, P.O. Box 487, Kimberley.

CAPE OF GOOD HOPE Stansfield Ratcliffe & Co., Ltd., Holland
(Eastern Province) Street, P.O. Box 798, Port Elizabeth.

Stansfield Ratcliffe & Co., Ltd., 197,
Oxford Street, P.O. Box 386, East
London.

NATAL, ZULULAND AND Stansfield Ratcliffe & Co., Ltd., 63,
EAST GRIQUALAND Anderson Street, P.O. Box 3223, Johan-
nesburg.

Stansfield Ratcliffe & Co., Ltd., 467,
Smith Street, P.O. Box 72, Durban.

Stansfield Ratcliffe & Co., Ltd., 221,
Commercial Road, Pietermaritzburg.

TRANSVAAL Stansfield Ratcliffe & Co., Ltd., 251,
Schoeman Street, P.O. Box 386, Pretoria.

SOUTHERN RHODESIA Stansfield Ratcliffe & Co., Ltd., 101, Main
Street, P.O. Box 254, Bulawayo.

BRITISH

JAEGER

INSTRUMENTS

CHRONOS WORKS
NORTH CIRCULAR ROAD
LONDON. N.W.2.

TELEPHONE:
GLADSTONE 1136 (5 LINES)
TELEGRAMS:
JAEGOMETER GOLD, LONDON.

MODEL "FA" AND "FAZ"
NON-TRIP TYPE

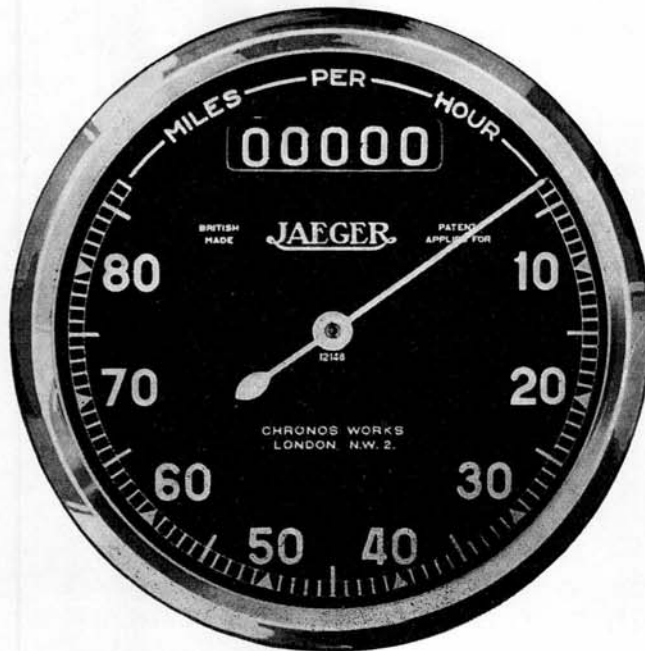

Actual size.

A FLUSH fitting instrument of extremely neat appearance and which has been specially designed for fitting to metal instrument boards.

Model "FA" clock matches this instrument, which may also be had with a white dial.

In the "FAZ" design, illumination slots are provided as shown in the accompanying illustration. These permit illumination of the instrument by means of a concealed light behind the dashboard.



PRICE (either type) :

Complete with gear box drive	£3 3 0
Extra for Cardan shaft drive ..	10 6
Extra for 120 miles per hour ..	10 6

BRITISH

JAEGER
INSTRUMENTS

CHRONOS WORKS
NORTH CIRCULAR ROAD
LONDON, N.W.2.

TELEPHONE:
GLADSTONE 1136 (5 LINES)
TELEGRAMS:
JAEGMETER. GOLD, LONDON.

MODEL "FA" & "FAZ" TRIP TYPE



Actual size.

AN instrument similar to the "FA" non-trip model, but with the addition of a trip recorder, the re-setting of which is done by means of the metal flex which is placed behind the board, only the button appearing beneath.

In the "FAZ" design, illumination slots are provided, as

shown in the illustration on page 6.

These permit illumination of the instrument by means of a concealed light behind the dashboard.

PRICE (either model) :

Complete with gear box drive ..	£4	4	0
Extra for Cardan shaft drive ..		10	6
Extra for 120 miles per hour ..		10	6

CHRONOS WORKS
NORTH CIRCULAR ROAD
LONDON. N.W.2.

BRITISH
JAEGER
INSTRUMENTS

TELEPHONE
GLADSTONE 1136 (8 LINES)
TELEGRAMS:
JAEGOMETER. GO D. LONDON

MOTOR CYCLE SPEEDOMETER

MODEL "FM"

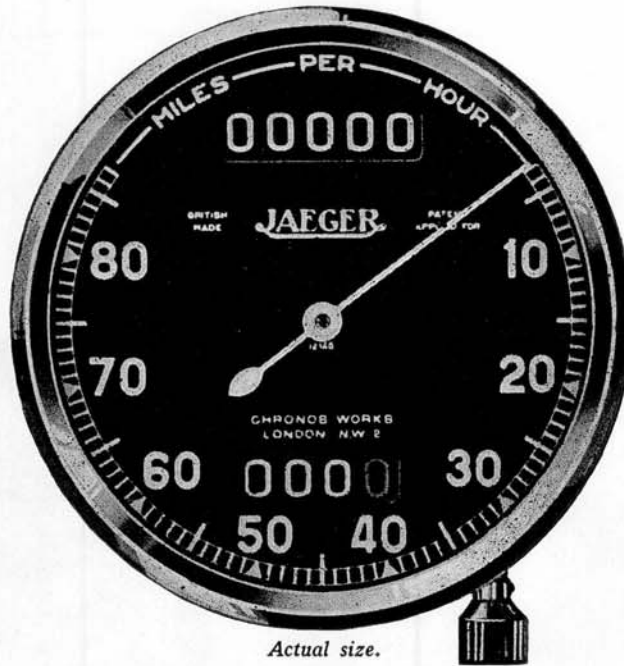

Actual size.

THIS Speedometer works on exactly the same principles as the other types of Jaeger Speedometers, and can be relied upon to withstand the most severe vibration. The hand remains absolutely steady at all speeds and the instrument records with unfailing accuracy. It is absolutely waterproof, a most important point on account of the exposed position when fitted to motor cycles.

The Jaeger Clip, for fixing the instrument to the handlebar, enables the instruments to be readily fixed to any diameter and type of handlebar or top tube.

PRICES :

Trip type complete with front wheel drive	£2 10 0
Non-trip type complete with front wheel drive	£2 5 0
Extra for back wheel drive	5 0
Trip Type (Head and Flex only)	£2 5 0
Non-Trip Type Ditto	£2 0 0

BRITISH

JAEGER

INSTRUMENTS

CHRONOS WORKS
NORTH CIRCULAR ROAD
LONDON. N.W.2.

TELEPHONE:
GLADSTONE 1136 (8 LINES)
TELEGRAMS:
JAEGOMETER. GOLD, LONDON.



THE NEW
5" SPEEDO-CLOCK



 HIS handsome two-in-one instrument, only recently introduced, has already proved itself a popular addition to our range of Instruments. It combines a 5-in. trip type Speedometer with a neat 8-day Clock, and the general effect is most pleasing.

Price, complete with Cable .. £9 9 0
(Allowance made for return of existing Clock or Speedometer)



BRITISH

JAEGER
INSTRUMENTS



CHRONOS WORKS,
NORTH CIRCULAR ROAD
LONDON, N.W.2.

TELEPHONE:
GLADSTONE 1136 (5 LINES)
TELEGRAMS:
JAEGOMETER, GOLD, LONDON.



5" REV-CLOCK FOR SPORTS CARS

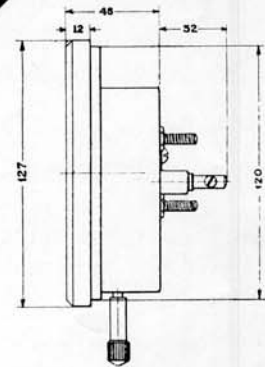
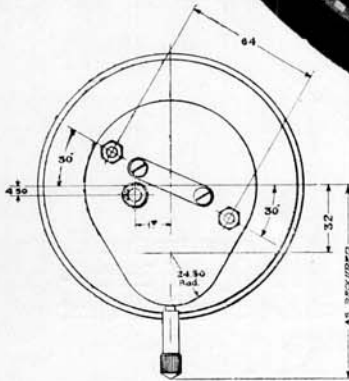
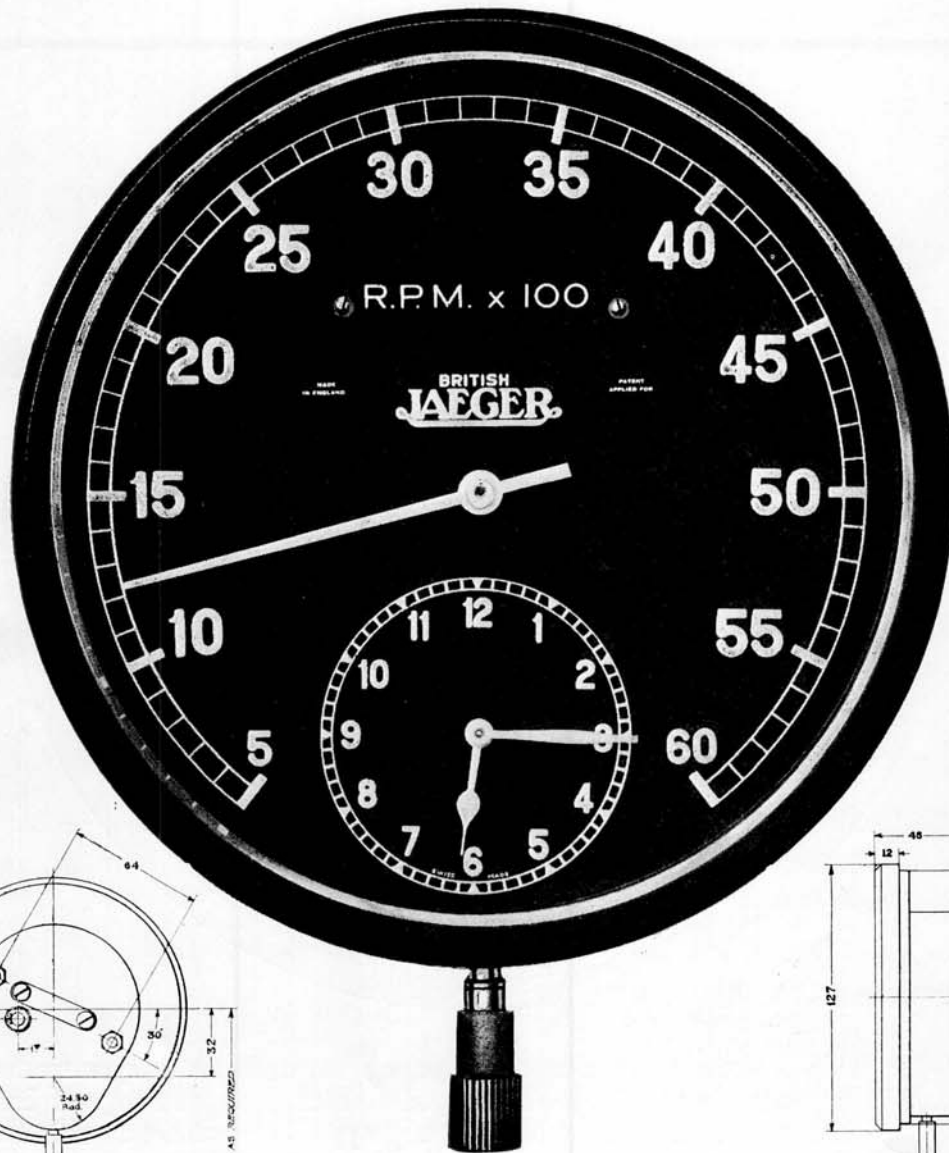

This attractive "Two-in-one" Instrument is ideal for Racing and Sports Car equipment, where space on the fascia board is limited. To read engine R.P.M. and Time at a single glance is a great asset when travelling at speed.

PRICE : With Cable only, £9 9 0

Pulley Drive 10/6 extra.

(Allowance made for return of existing Clock or Rev. Counter.)

BRITISH

JAEGER

INSTRUMENTS

CHRONOS WORKS
NORTH CIRCULAR ROAD
LONDON, N.W.2.

TELEPHONE:
GLADSTONE 1136 (5 LINES)
TELEGRAMS:
JAEGOMETER, GO D, LONDON.



3" REV - CLOCK

(PATENT APPLIED FOR)

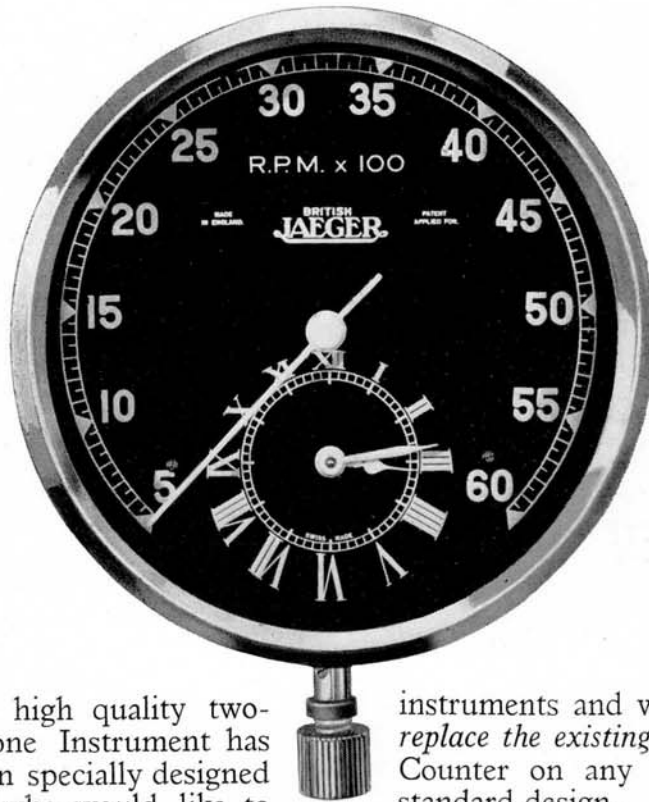

THIS high quality two-in-one Instrument has been specially designed for owners who would like to have a Rev. Counter and Clock, but have only *one* hole available in the dashboard.

instruments and will, therefore, *replace the existing* Clock or Rev. Counter on any dashboard of standard design.

The size of this instrument has been carefully kept down to the standard diameter of our

PRICE :

Complete with Cable Drive	£7 7 0
Extra for Pulley Drive	10 6

(Allowance made for return of existing Clock or Rev. Counter.)

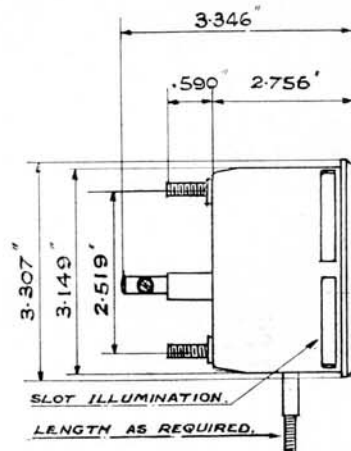

BRITISH

JAEGER

INSTRUMENTS

CHRONOS WORKS,
NORTH CIRCULAR ROAD
LONDON, N.W.2.

TELEPHONE:
GLADSTONE 1136 (5 LINES)
TELEGRAMS:
JAEGOMETER, GOLD, LONDON.



RACING SPEEDOMETER



Actual size.

A special instrument for Sports Cars, reading up to 150 m.p.h., and embodying the same degree of accuracy as the standard models. The 6 in. diameter dial and clear markings ensure quick reading at speed. As used by practically all the famous Racing Drivers.

PRICE :

Complete with gear box drive showing M.P.H. only ..	£8 8 0
Non-Trip Type, complete with gear box drive ..	£9 9 0
Trip Type, ditto	£10 10 0

BRITISH

CHRONOS WORKS.
NORTH CIRCULAR ROAD
LONDON, N.W.2.

JAEGER

INSTRUMENTS

TELEPHONE:
GLADSTONE 1136 (8 LINES)
TELEGRAMS:
JAEGOMETER GOLD, LONDON.

RACING REVOLUTION COUNTER



Actual size.

An extremely valuable instrument for all Sports Cars, supplied to any required calibration. The 6 in. diameter dial and well-defined figures ensure the correct revolutions of the engine being read at speed. This instrument is nearly always found on the Dashboards of the winning Cars, and is chosen by most of the famous Racing Drivers.

With cable only £8 8 0

Extra for pulley drive 10 6

BRITISH

JAEGER

INSTRUMENTS

CHRONOS WORKS
NORTH CIRCULAR ROAD
LONDON. N.W.2.

TELEPHONE:
GLADSTONE 1136 (5 LINES)
TELEGRAMS:
JAEGOMETER. GOLD, LONDON.



5" SPEEDOMETER
FOR SPORTS CARS

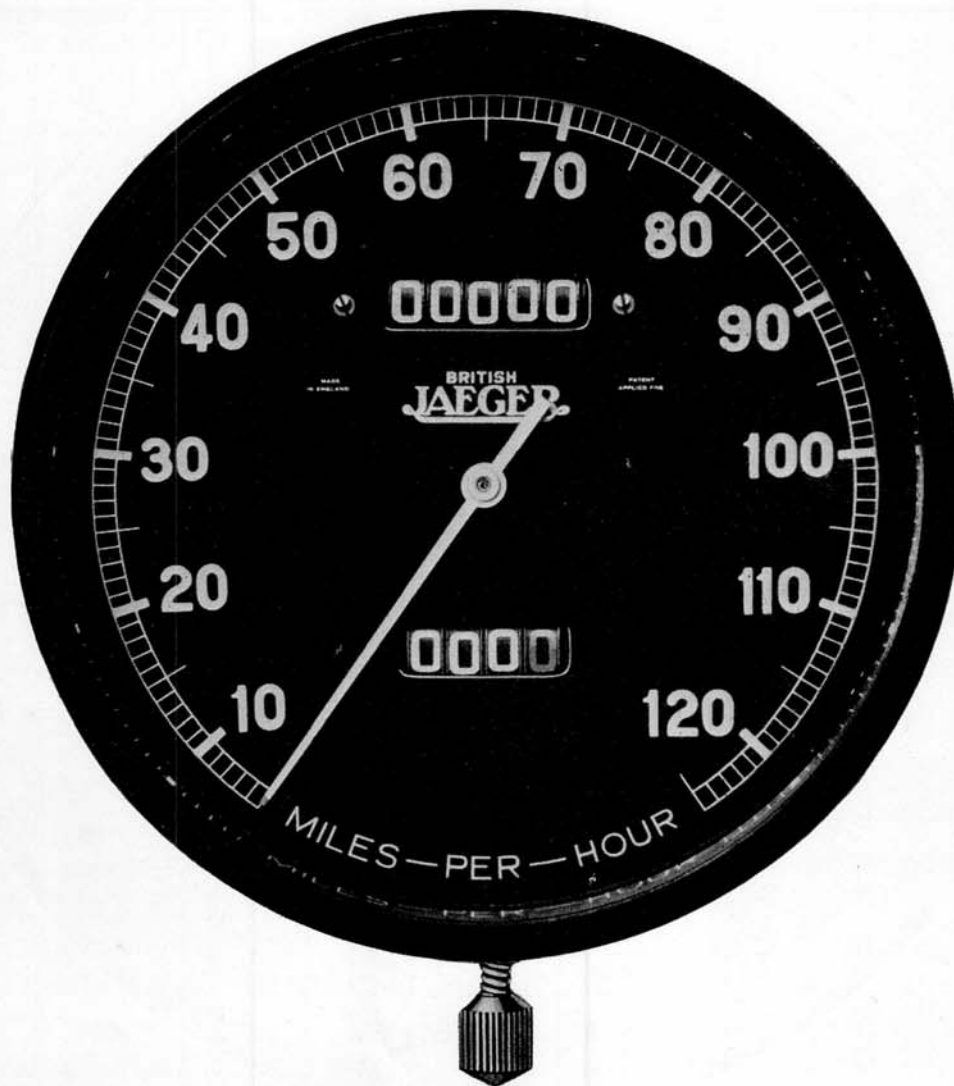

THIS instrument with 5 in. diameter, recently placed on the market, has quickly found favour, owing to its accuracy and extremely clear dial.

Combining all the well-known characteristics of Jaeger manufacture, it enhances the appearance of any dashboard.

Price with Cable up to 7 ft. £6 6 0



CHRONCS WORKS
NORTH CIRCULAR ROAD
LONDON. N.W.2.

BRITISH

JAEGER
INSTRUMENTS



TELEPHONE:
GLADSTONE 1136 (5 LINES)
TELEGRAMS:
JAEGOMETER. GOLD. LONDON.



5" REV. COUNTER

FOR SPORTS CARS



A COMPANION to the Speedometer shown on page 14, it accurately records the revs. per minute of the engine. The clear dial and steady readings are great assets when travelling at speed.

Price with Cable up to 7 ft.	£6 6 0
Extra for Pulley drive	10 6



BRITISH

JAEGER

INSTRUMENTS



CHRONOS WORKS
NORTH CIRCULAR ROAD
LONDON, N.W.2.

TELEPHONE:
GLADSTONE 1136 (5 LINES)
TELEGRAMS:
JAEGMETER. GOLD, LONDON.



ELECTRIC PETROL GAUGE



52 mm. diameter. This is an entirely new design of Petrol Gauge, registering in gallons the exact contents of the tank. Can be supplied with or without illuminating windows. One feature of this instrument is that there is nothing to be done in the way of using a pump or handling in any way, being entirely independent of the driver. As long as there is petrol in the tank, the instrument registers the amount without any operation.

The reading is obtained by means of a float and lever in the tank, which is connected electrically to the dial fitted to the dashboard.

Price on application.



OIL AND PETROL LEVEL GAUGE

This gauge has been developed with a view to meeting the demand for a gauge reading direct on the instrument board and registering, as required, both the level of the Petrol in the Tank and record of the oil in the Sump. The principle of operation is similar to the Electric Petrol Gauge.

Price on application.

It will be appreciated that due to the construction of the Float arrangement and the need for special calibrations, these two types of Petrol Gauges are produced for the requirements of Car Manufacturers only.

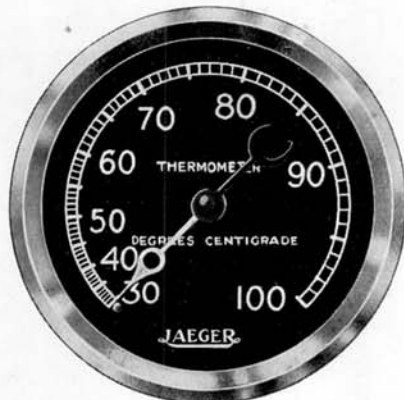

DASHBOARD RADIATOR THERMOMETER

This instrument, which is similar to that used on all aircraft, gives the temperature of the water in the radiator, in the most favourable position, i.e., on the dashboard. The instrument is of extreme simplicity of construction, is very easily fitted, and is supplied complete with tubing suitable for any make of car.

Price : With 6 ft. Capillary Tubing .. 25/-

Actual sizes



BRITISH

JAEGER

INSTRUMENTS

CHRONOS WORKS
NORTH CIRCULAR ROAD
LONDON, N.W.2.

TELEPHONE:
GLADSTONE 1136 (5 LINES)
TELEGRAMS:
JAEGOMETER, GOLD, LONDON.



OIL PRESSURE GAUGE

52 mm. diameter, with or without side window illumination. Can be supplied up to pressures of from 10 lb. to 160 lb. per square inch, and is finished to exactly match all other Jaeger instruments.

Price :—

0- 25 lb.	} 15/-
0- 40 lb.	
0- 60 lb.	
0-100 lb.	
0-160 lb.	



SHUTTER TYPE OIL GAUGE

This instrument has found favour with those who wish to know at a glance whether the oil is in circulation. The size is 52 mm. diameter, and it can be supplied with or without side window illumination.

Price 25/-



DASHBOARD OIL THERMOMETER

A most useful dashboard instrument giving the temperature of the oil. This instrument is soundly constructed, and is supplied complete with tubing, suitable for any make of car.

Price : With 6 ft. Capillary Tubing . . . 25/-



BRITISH

JAEGER

INSTRUMENTS

CHRONOS WORKS,
NORTH CIRCULAR ROAD
LONDON, N.W.2.

TELEPHONE: GLADSTONE 1136 (5 LINES)
TELEGRAMS: JAEGOMETER, GOLD, LONDON.



COMBINED INTERIOR MIRROR AND 8-DAY HANDLESS CLOCK



Half size

THIS is an entirely new and attractive design, which combines an interior mirror of ample dimensions with an 8-day clock movement of our standard high quality, but designed in such a way as to dispense with the need of the dial lay-out and the hands. The illustration shows the method of giving the time in figures of ample size, which can be read at a glance by the occupants of a car, including those in the rear passengers' seat. In spite of the size given to these figures, it will be found that they do not by any means interfere with the use of the mirror. The eyes of the driver absorb the figures into the general view, when he is using the mirror as such. There are two sizes, the dimensions of which are as follows :

- 1.—7 × 3 $\frac{1}{4}$ in.
- 2.—6 × 3 $\frac{1}{4}$ in.

RETAIL PRICES :

Code No. C.60	£2 17 6
Code No. C.61 (smaller size)	£2 15 0



BRITISH

JAEGER

INSTRUMENTS



CHRONOS WORKS,
NORTH CIRCULAR ROAD
LONDON, N.W.2.

TELEPHONE:
GLADSTONE 1136 (3 LINES)
TELEGRAMS:
JAEGOMETER. GOLD, LONDON.

MODEL "FA" & "FAZ" CLOCK



Actual size

A FLUSH fitting 8-day clock particularly suitable for metal instrument boards. It is wound by means of the metal flex shown, only the button of which appears below the instrument board.

This instrument matches the "FA" Speedometer, and may also be had with a white dial.

In the "FAZ" design,

illumination slots are provided, as shown in the accompanying illustration. These permit illumination of the instrument by means of a concealed light behind the dashboard.

Long experience in the manufacture of chronometric instruments enables us to produce a clock of irreproachable mechanism for motor car work.



PRICE :

Either type £2 12 6

BRITISH

JAEGER

INSTRUMENTS

CHRONOS WORKS.
NORTH CIRCULAR ROAD
LONDON, N.W.2.

TELEPHONE:
GLADSTONE 1136 (5 LINES)
TELEGRAMS:
JAEGMETER, GOLD, LONDON.



MODEL "FA6" CLOCK



Actual size.

THE small size and neat appearance of this 8-day Clock allows it to be fitted to the car interior, or in a canteen, as shown by the above illustration.

This feature will also permit its being fitted to a dashboard where the available space is limited, it being only 2 in. in diameter. Supplied, if desired, with window illumination as illustrated.



Price	£1 10 0
Also 2 in. in diameter ..	£1 10 0

BRITISH

JAEGER

INSTRUMENTS

CHRONOS WORKS.
NORTH CIRCULAR ROAD
LONDON, N.W.2.

TELEPHONE:
GLADSTONE 1136 (8 LINES)
TELEGRAMS:
JAEGOMETER. GOLD. LONDON.



CHRONOGRAPH

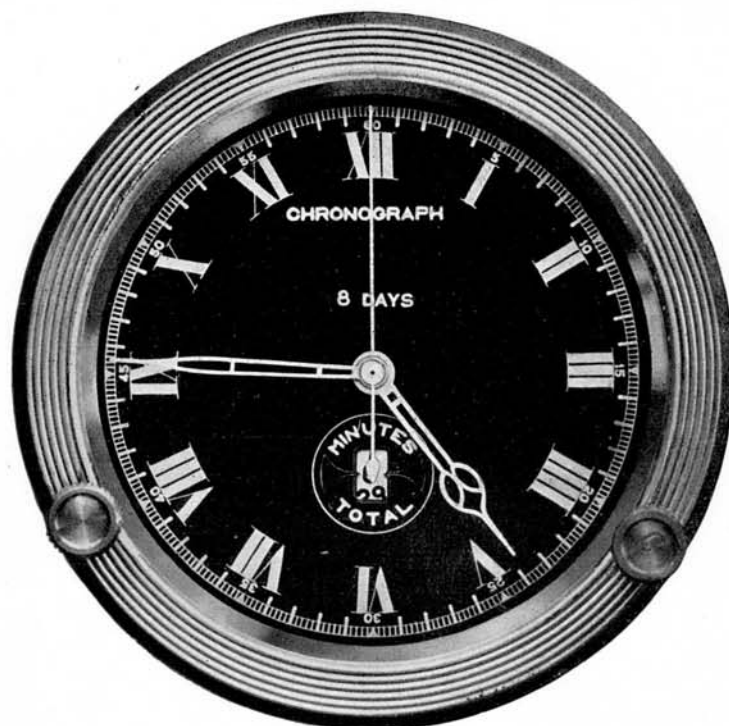

Actual size.

THIS 8-day Clock also embodies a stop-watch mechanism which records to a fifth of a second with perfect accuracy (the total number of minutes being recorded on the small counter within the dial). The start, stop and fly-back action is actuated by the right-hand button. Wind and set hands by means of left-hand button.

These additional features to the Clock will be found very useful, as it enables an accurate check on speed to be obtained.

As used by many famous Racing, Trial and Rally drivers.

The instrument may also be had with a white dial.

PRICE £7 7 0

BRITISH

JAEGER

INSTRUMENTS

CHRONOS WORKS.
NORTH CIRCULAR ROAD
LONDON, N.W.2.

TELEPHONE:
GLADSTONE 1136 (5 LINES)
TELEGRAMS:
JAEGOMETER, GOLD, LONDON.



MOTOR CYCLE CLOCK

MODEL "FM"

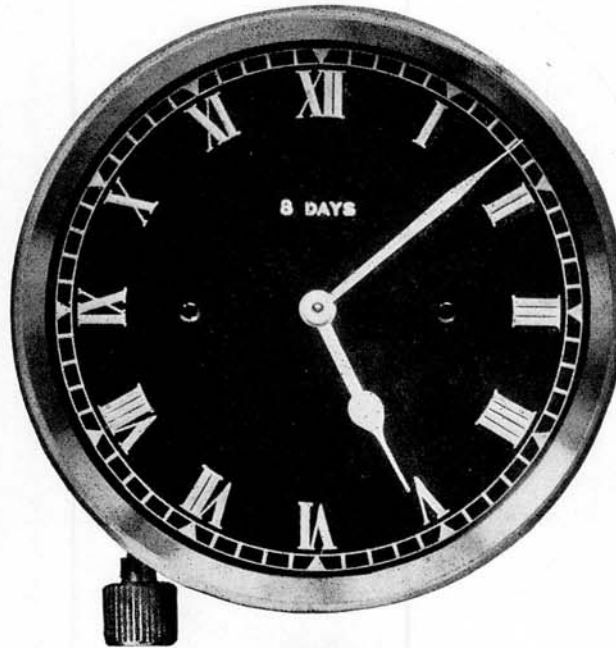

Actual size.

THE Motor Cycle 8-day Clock is made to match the Speedometer. It is capable of withstanding the most excessive vibration and has the same perfect mechanism and time-keeping qualities of the other Jaeger Clocks, and is perfectly waterproof. The Jaeger Clip for fixing to any diameter and type of handlebar enables this clock to be easily fitted.

PRICES :

Complete	£1 15 0
Model FM 6 type, same appearance, but $2\frac{3}{8}$ in. diameter ..	£1 10 0
Also in 2 in. diameter ..	£1 10 0



BRITISH

JAEGER

INSTRUMENTS



CHRONOS WORKS,
NORTH CIRCULAR ROAD
LONDON, N.W.2.

TELEPHONE:
GLADSTONE 1136 (5 LINES)
TELEGRAMS:
JAEGOMETER GOLD, LONDON.

NON-FLUSH TYPE CLOCKS

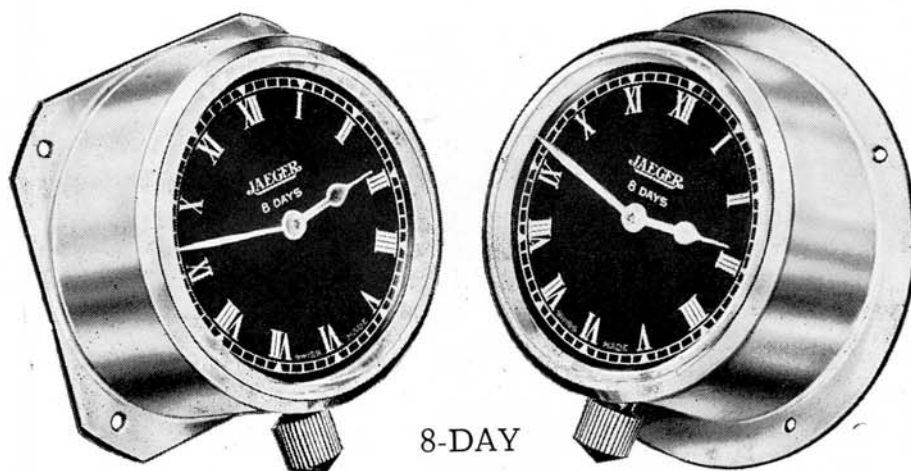

Actual size.

Actual size.

8-DAY

A NEW design of Watch for the dashboard or car interior, at an exceptionally low price, produced to meet the demand for an accurate timepiece for those cars which have not one fitted as standard equipment.

Supplied with black or white dial, round or square case, and *screws on to* the dashboard, obviating the necessity of cutting a hole to accommodate it.

Dial diameter $2\frac{3}{8}$ in.

PRICE :

No. F 210	Round Flange ..	} £1 10 0
No. F 211	Square Flange ..	

BRITISH

JAEGER

INSTRUMENTS

CHRONOS WORKS,
NORTH CIRCULAR ROAD
LONDON, N.W.2.

TELEPHONE:
GLADSTONE 1136 (5 LINES)
TELEGRAMS:
JAEGOMETER, GOLD, LONDON.



INTERIOR CLOCKS

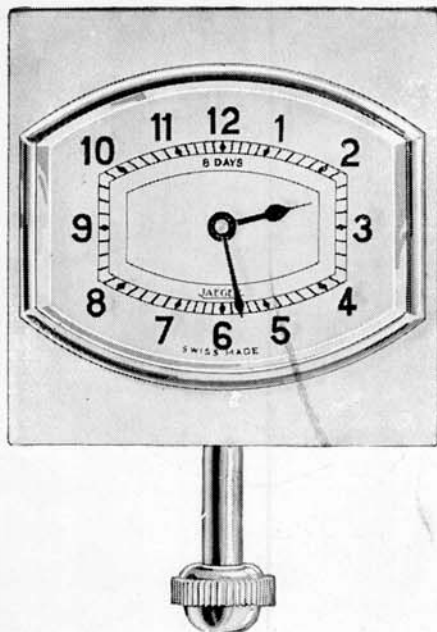

Actual size.

FLUSH FITTING TYPE

THESE neat 8-day clocks are reliable timepieces of unusual design and finished in a variety of novel and pleasing styles.

This type is intended to be recessed into a panel cut to the correct shape, the long stem of the keyless winder protruding below the panel for both winding and setting.

Can be supplied with either white or black dial with polished nickel rim or with gilt dial and gilt case.

PRICES :

No. 206	Flush fitting, white dial, polished rim ..	£2 2 0
No. 207	Flush fitting, black dial, polished rim ..	£2 2 0
No. 208	Gilt finish, flush fitting type	£2 15 0

ADJUSTABLE BRACKET TYPE

THIS adjustable bracket type enables these clocks to be fixed to any convenient part of the interior coachwork, and adjusted so as to be readily visible to all passengers in the rear of the car. Only two small screws are necessary to secure the clock rigidly and permanently in position. White or black dial can be provided.

PRICES :

No. 205	Bracket type, black dial, polished rim ..	£2 10 0
No. 209	Bracket type, white dial, polished rim ..	£2 10 0

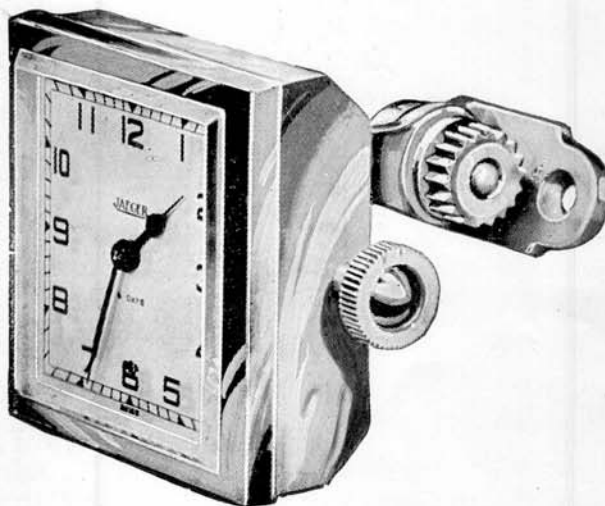

Actual size

BRITISH

JAEGER

INSTRUMENTS

CHRONOS WORKS
NORTH CIRCULAR ROAD
LONDON. N.W.2.

TELEPHONE:
GLADSTONE 1136 (5 LINES)
TELEGRAMS:
JAEGOMETER. GO. D. LONDON.

MODEL "FA" & "FAZ" REVOLUTION INDICATOR

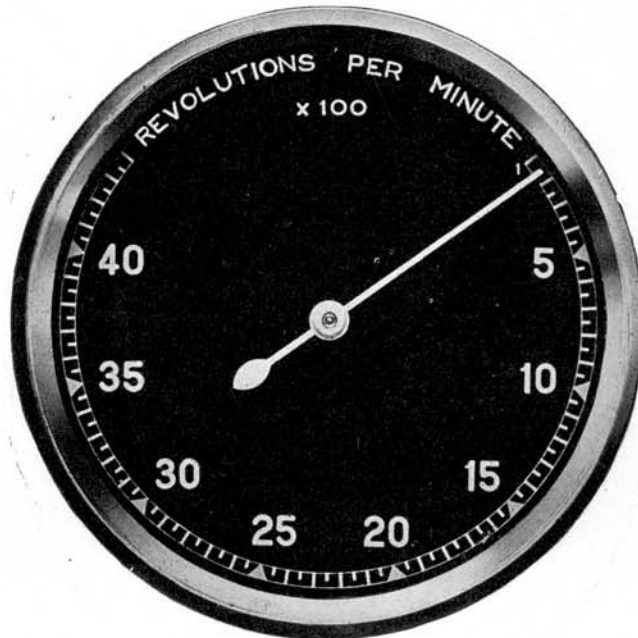

Actual size.

A FLUSH fitting Indicator made to match the "FA" or "FAZ" Speedometer and Clock, and is a very useful instrument to have on the dashboard.

In the "FAZ" design, illumination slots are provided, as shown in the accompanying illustration. These permit illumination of the instrument by means of a concealed light behind the dashboard.



PRICE :

With cable only	£4 4 0
Extra for pulley drive	10 6

CHRONOS WORKS.
NORTH CIRCULAR ROAD
LONDON. N.W.2.

BRITISH
JAEGER
INSTRUMENTS

TELEPHONE:
GLADSTONE 1136 (5 LINES)
TELEGRAMS:
JAEGOMETER GOLD, LONDON.



MODEL "FA" AND "FAZ"

SHOWING SPEED ONLY



Specially suitable for Passenger-carrying Vehicles

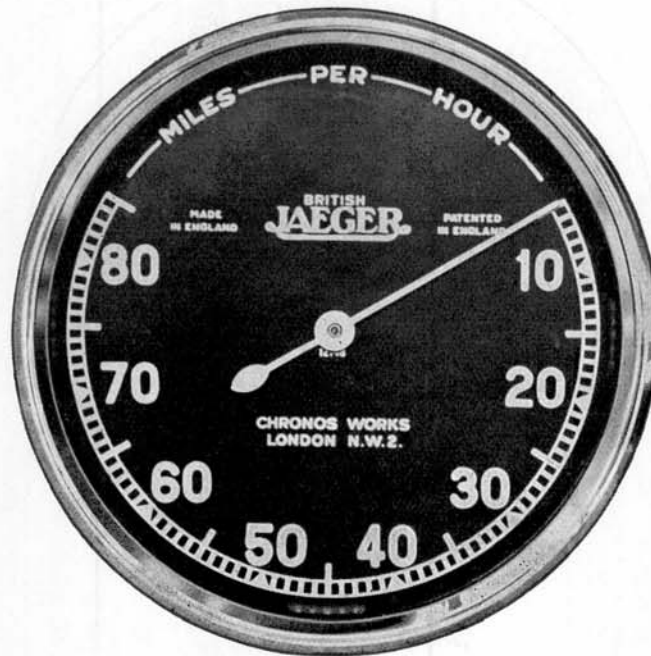

THIS instrument has been specially produced to meet the need that has arisen for a Speed Indicator without total mileage or trip. In order to comply with the Regulations of the Ministry of Transport, all Public Service vehicles should be fitted with a Speed Indicator. Many of these vehicles are on specific routes, the mileage of which is thoroughly well known by the owners and, therefore, it is not so necessary for the instrument to show total mileage, or daily trip.

PRICE :

Head complete with flexible cable up to 7 ft.	£2 17 6
Can be supplied complete with pulley drive from the Cardan shaft	£4 4 0



BRITISH

JAEGER

INSTRUMENTS



CHRONOS WORKS
NORTH CIRCULAR ROAD
LONDON. N.W.2.

TELEPHONE:
GLADSTONE 1136 (8 LINES)
TELEGRAMS:
JAEGOMETER. GOLD. LONDON.



MODEL "F" MILEAGE RECORDER

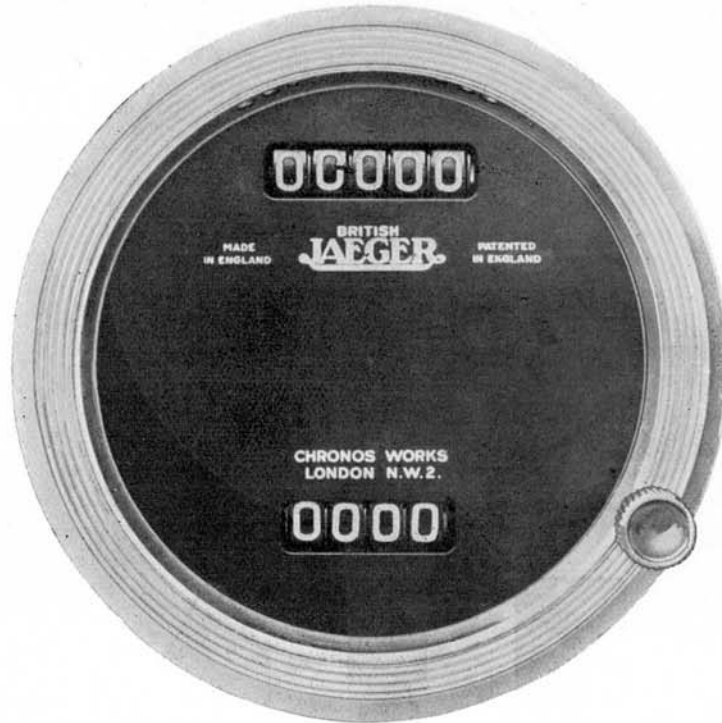

THIS instrument may be fitted on the dashboard in the same method as a Speedometer, or, if preferred, it can be fitted on the side of the chassis, as close as possible to the gear box drive. The mileage may then be used privately by the Contractor, for reading various journeys and making a charge according to the mileage shown.

By means of a two-way gear box, the instrument can also be used in conjunction with the Speedometer only (shown on page 26). This would mean that speed would be shown on the dashboard in front of the driver, and the mileage would be shown on the side of the chassis.

The total records 100,000 miles, and the trip 1,000 miles.

The trip can be easily re-set to zero by means of the button, which can, by special arrangement, be fitted with a Padlock for a small extra cost.

	PRICE :		
Head complete with cable, Trip Type	..	£3 5 0	
Non-Trip Type, with cable	2 10 0	



CHRONOS WORKS.
NORTH CIRCULAR ROAD
LONDON, N.W.2.

BRITISH
JAEGER
INSTRUMENTS



TELEPHONE:
GLADSTONE 1136 (5 LINES)
TELEGRAMS:
JAEGOMETER, GOLD, LONDON.



TACHOMETER

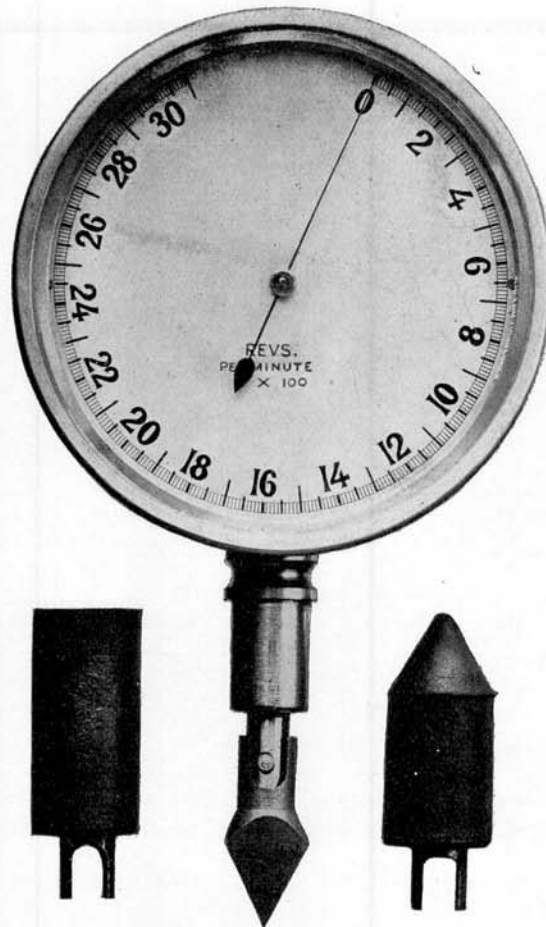

Actual size.

THE need for a Chronometric Tachometer is being felt more and more urgently in modern industry. It is indispensable for experimental work where the exact speed of any machine or part has to be determined, and is also useful in the laboratory.

This instrument, owing to its extremely reduced size, can also be permanently fitted to machines offering the minimum of available space. It gives an instantaneous reading in r.p.m., and is supplied in a pocket case with one triangular and two rubber points.

PRICE :

Complete with fittings £4 4 0

CHRONOS WORKS
NORTH CIRCULAR ROAD
LONDON. N.W.2.

BRITISH
JAEGER
INSTRUMENTS

TELEPHONE:
GLADSTONE 1136 (5 LINES)
TELEGRAMS:
JAEGOMETER. GO. D. LONDON.